



MMB Hydraulic Cylinders

'Mill type' roundline cylinders for working pressures up to 160 bar

aerospace
climate control
electromechanical
filtration
fluid & gas handling
hydraulics
pneumatics
process control
sealing & shielding



ENGINEERING YOUR SUCCESS.

Introduction

Series MMB 'mill type' roundline cylinders deliver continuous high performance with low whole-life costs in arduous applications such as steel mills, where a rugged, durable cylinder with a 'clean' external design is required.

In addition to the standard cylinders featured in this catalogue, MMB cylinders can be designed and manufactured to suit individual customer requirements.

Standard Specifications

- Heavy Duty construction
- Styles and dimensions to CETOP RP58H and ISO 6020/1
- Rated pressure: 160 bar
- Fatigue-free at the rated pressure
- Hydraulic mineral oil – others on request
- Temperature range of standard seals: -20°C to +80°C
- Construction: head and cap bolted to heavy steel flanges
- Bore sizes: 40mm to 320mm
- Piston rod diameters: 22mm to 220mm
- Cushioning – optional at both ends
- Air bleeds – optional at both ends
- Tested in accordance with ISO 10100 : 2001

Contents

	Page
Design Features and Benefits	3
Optional Features	4
Rectangular Flange Mountings	5
Circular Flange Mountings	6
Pivot Mountings	7
Foot and Trunnion Mountings	8
Piston Rod End Data	9
Accessories	10
Mounting Information	13
Cylinder Masses	13
Selecting the Cylinder Diameter	14
Selecting the Piston Rod	15
Stroke Factors	15
Long Stroke Cylinders	16
Stop Tubes	16
Ports	17
Cushions	18
Seals and Fluids	20
Replacement Parts and Service	21
How to Order Cylinders	23

Parker – Committed to Your Success

Parker Hannifin is the global leader in motion and control technologies. We employ more than 58,000 people in 48 countries, providing our customers with technical excellence and first class customer service. Parker is the world's largest supplier of hydraulic cylinders for industrial applications.

When you partner with Parker, you gain access to a vast range of resources designed to increase your productivity and profitability.

- CAD drawings
- Custom solutions
- Application guidance
- Maintenance information
- Product updates
- Other language content
- Access to other Parker products and services

3-D CAD

New 3-D CAD software simplifies the process of selecting and drawing a cylinder, saving time and ensuring the accuracy of the finished design. Scan the QR code to view MMB cylinders on line at www.parker.com or contact your local Sales Office – see rear cover.

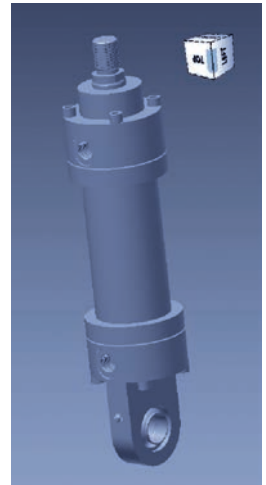

WARNING – USER RESPONSIBILITY

FAILURE OR IMPROPER SELECTION OR IMPROPER USE OF THE PRODUCTS DESCRIBED HEREIN OR RELATED ITEMS CAN CAUSE DEATH, PERSONAL INJURY AND PROPERTY DAMAGE.

This document and other information from Parker-Hannifin Corporation, its subsidiaries and authorized distributors provide product or system options for further investigation by users having technical expertise.

The user, through its own analysis and testing, is solely responsible for making the final selection of the system and components and assuring that all performance, endurance, maintenance, safety and warning requirements of the application are met. The user must analyze all aspects of the application, follow applicable industry standards, and follow the information concerning the product in the current product catalog and in any other materials provided from Parker or its subsidiaries or authorized distributors.

To the extent that Parker or its subsidiaries or authorized distributors provide component or system options based upon data or specifications provided by the user, the user is responsible for determining that such data and specifications are suitable and sufficient for all applications and reasonably foreseeable uses of the components or systems.

Offer of Sale

Please contact your Parker representation for a detailed "Offer of Sale".

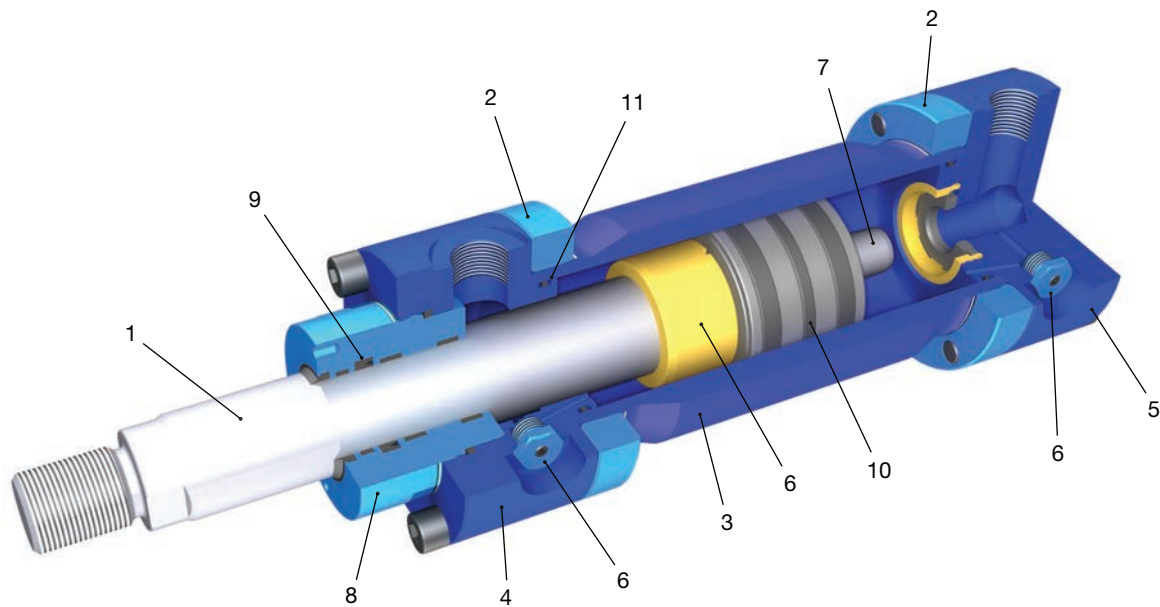

1 Piston Rod

The piston rod is manufactured from precision ground, high tensile carbon alloy steel, hard chrome plated and polished to 0.2µm max. Piston rods up to 140mm in diameter are induction case hardened to Rockwell C54 minimum before chrome plating. This provides a 'dent resistant' surface, resulting in improved seal life. Piston rods of 160mm diameter and above can be case hardened on request. All rod and piston assemblies are designed to be fatigue free at full rated pressure.

2 Head and Cap Retention

The head and cap are bolted to heavy steel flanges, which are retained by threads at each end of the cylinder body. The resulting assembly is fatigue-free at its maximum rated pressure.

3 Cylinder Body

The heavy wall steel tubing is honed to a high surface finish, to minimise internal friction and prolong seal life.

4 & 5 Head & Cap Ends

The head and cap are machined from steel and located into the cylinder body's internal diameter for added strength and precise alignment. To ensure leak-free performance, both the head and cap are sealed by 'O' rings which, in turn, are protected by anti-extrusion rings.

6 & 7 Cushioning

Optional cushions at the head and cap are progressive in action, providing controlled deceleration which reduces noise and shock loading, and prolongs machine life. The head end cushion is a self-centring sleeve, while the polished cap end spear is an integral part of the piston rod. Needle valves are provided at both ends of the cylinder for precise cushion adjustment, and are recessed and retained so that they cannot be inadvertently removed.

Check valves at the head and cap ends of the cylinder minimize restriction to the start of a stroke, permitting full power and fast cycle times. The head end check valve is incorporated into the fully floating cushion sleeve, while the cap end employs a floating bronze cushion bush.

8 & 9 Rod Gland, Seals and Bearings

The gland seals are located in a detachable gland housing for quick, easy maintenance, and provide efficient retention of pressurized fluid while preventing the ingress of contaminants.

The detachable steel rod gland features heavy duty polymer bearing rings to resist side loadings. Wide separation of these rings reduces bearing stresses, maximising service life.

The polymer bearing rings, with the rod seals, are easily replaced on removal of the rod gland, and all components may be serviced without further disassembly of the cylinder.

10 Piston Seals

Standard, load holding and chevron-type piston seal options are available, to suit different applications – see page 4. In addition, MMB cylinders can be designed and manufactured to suit individual customer requirements. Please contact the factory for details.

11 Body End Seals

To ensure leak-free performance, body end seals and gland/head seals are of radial construction, avoiding the problems of 'nibbling' and early failure associated with face-type seals.

Gland and Piston Seal Options

See illustrations, page 21

Standard Option

The standard seals fitted to MMB cylinders provide excellent low speed and break-out performance and deliver exceptional working life in high cycle applications. They may be used with all fluid groups (see page 20) at piston speeds up to 0.5m/s.

Standard gland seals comprise a heavy duty lipseal and wiperseal for efficient sealing, while the pistons are fitted with a filled polymer seal and wear rings which prevent metal contact with the cylinder bore and help to protect the piston seal from contaminants.

Chevron Option

The combination of chevron gland and chevron piston seals is designed to withstand harsh environments such as steel mills. They are suitable for use with all fluid groups and for piston speeds up to 0.5m/s, and may be used to hold a load in position.

Chevron gland seals have a steel retainer, and a separate removable steel housing which retains the inner bearing rings. A heavy duty wiper seal prevents the ingress of contaminants. Chevron pistons feature a two-piece piston with a wide bearing ring mounted between chevron seals.

Load Holding Option

Suitable for applications where loads are required to be held in position, the Load Holding option combines the low friction performance and long life of the standard gland seals with the rugged qualities of the chevron piston seal. The load holding option may be used for piston speeds up to 0.5m/s and is suitable for use with all fluid groups.

Air Bleeds

Available as an option at both ends, air bleeds are recessed into the head and cap and retained so they cannot be inadvertently removed. The air bleed location, in relation to the supply port location, must be specified on the order – see page 23.

Gland Drains

The tendency of hydraulic fluid to adhere to the piston rod can result in an accumulation of fluid in the cavity between the seals under certain operating conditions. This may occur with long stroke cylinders, where there is a constant back pressure as in differential circuitry, or where the ratio of the extend speed to the retract speed is greater than 2 to 1.

Gland drains should be piped back to the fluid reservoir, which should be located below the level of the cylinder.

Position Switches and Feedback Devices

Non-contacting position switches and linear position transducers of various types may be fitted to MMB series cylinders. Please contact the factory for further details.

Rod End Bellows

Exposed rod surfaces that are subjected to air hardening contaminants should be protected by rod end bellows. Longer rod extensions are required to accommodate their collapsed length – please consult the factory for details.

Rod Material

As an alternative to the normal piston rod material, stainless steel and other special materials and finishes can be supplied.

Metallic Rod Wipers

For applications where contaminants may adhere to the extended piston rod and thereby cause premature failure of gland seals, the use of a metallic rod wiper in place of the standard wiper seal is recommended.

Double Rodded Cylinders

MMB series cylinders are available with the option of a double-ended piston rod. Please contact the factory for details.

Special Designs

Alternative sealing arrangements, special mounting styles, higher or lower rated pressures, double-rodded cylinders, welded cap ends to reduce overall length (non-cushioned only), larger bores, alternative rod sizes and special paint finishes are just a few of the special requirements which can be accommodated.

Marine Environments

MMB cylinders can be supplied with modifications to material and paint specifications which make them suitable for operation in a marine environment. Please consult the factory.

Servicing Features

All cylinders will, at some time, need maintenance or repairs. For maximum productivity with minimum downtime, the MMB series incorporates the following design features:

- **Removable Gland** – Rod bearing and rod seals can be replaced without completely dismantling the cylinder.
- **Chamfers** at both ends of the cylinder body ease assembly of the head and cap and insertion of the piston seals.
- **Retaining flanges** are removable, allowing separate replacement of the cylinder body. Flanges are spaced from the head and cap to allow the bolts to be sawn through in the event of severe damage or corrosion.
- **High tensile bolts** are used for ease of maintenance.

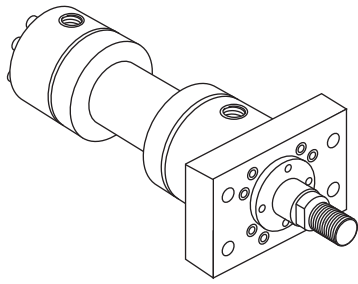

Style MF1
 Head Rectangular Flange

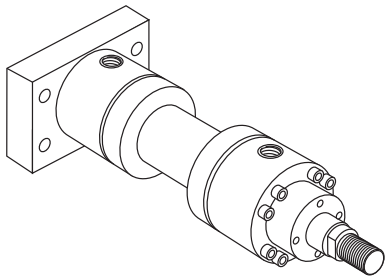
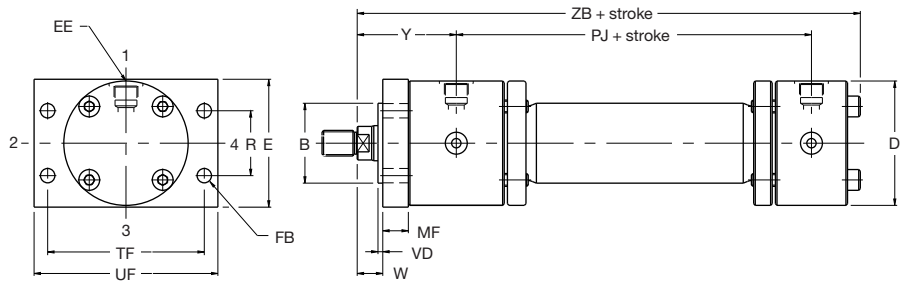

Style MF2
 Cap Rectangular Flange

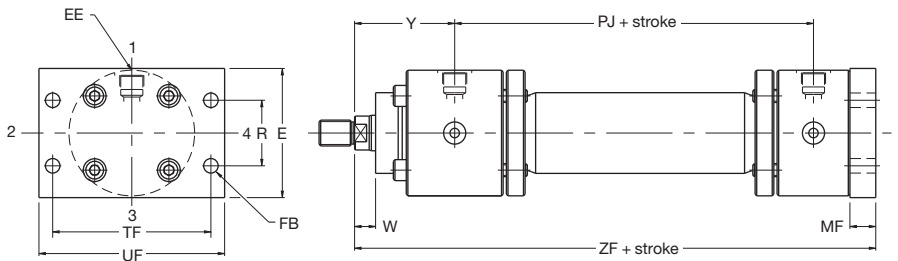

Dimensions – MF1 and MF2 See also Rod End Dimensions, page 9

Bore Ø	Rod No.	Rod Ø	B f8	D max	E	EE (BSPP)	FB	MF	R	TF	UF	VD	W	Y	+ Stroke		
															PJ	ZB max	ZF
40	1 2	22 28	50	78	80	G½	9	16	40.6	98	115	3	16	71	97	198	206
50	1 2	28 36	60	95	100	G½	11	20	48.2	116.4	140	4	18	72	111	213	225
63	1 2	36 45	70	116	120	G¾	13.5	25	55.5	134	160	4	20	82	117	236	249
80	1 2	45 56	85	130	135	G¾	17.5	32	63.1	152.5	185	4	22	91	134	262	282
100	1 2	56 70	106	158	160	G1	22	32	76.5	184.8	225	5	25	108	162	314	332
125	1 2	70 90	132	192	195	G1	22	32	90.2	217.1	255	5	28	121	174	341	357

All dimensions are in millimetres unless otherwise stated.

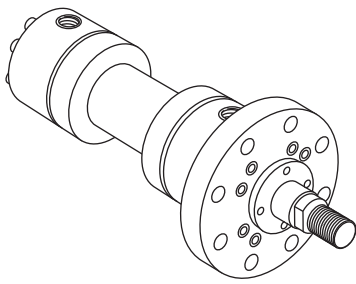

Style MF3
Head Circular Flange

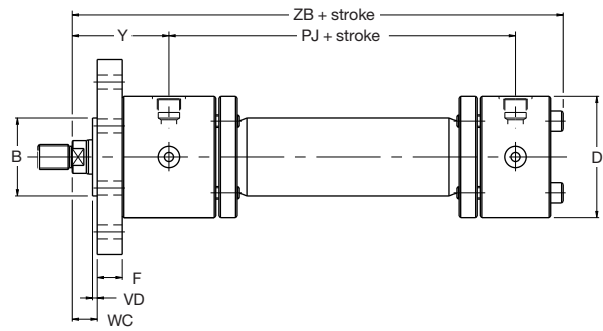
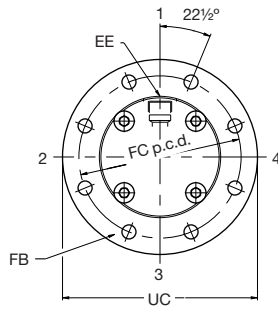

Accurate location of 'B' provided as standard on model MF3 only.

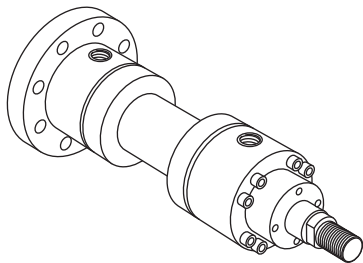

Style MF4
Cap Circular Flange

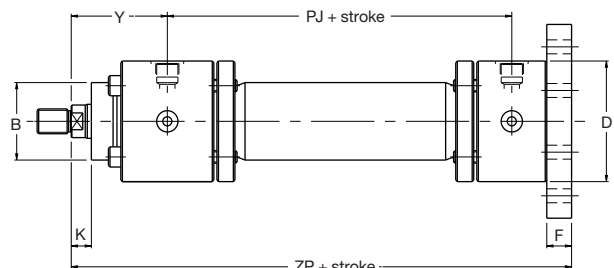
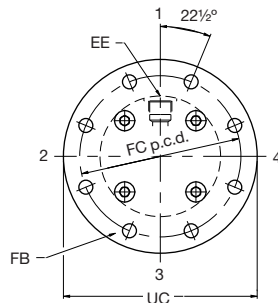

Dimensions – MF3 and MF4 See also Rod End Dimensions, page 9

Bore Ø	Rod No.	Rod Ø	B f8	D max	EE (BSPP)	F	FB	FC	K	UC max	VD min	WC	Y	+ Stroke		
														PJ	ZB max	ZP
40	1 2	22 28	50	78	G ¹ / ₂	16	9	106	13	125	3	16	71	97	198	206
50	1 2	28 36	60	95	G ¹ / ₂	20	11	126	14	148	4	18	72	111	213	225
63	1 2	36 45	70	116	G ³ / ₄	25	13.5	145	16	170	4	20	82	117	236	249
80	1 2	45 56	85	130	G ³ / ₄	32	17.5	165	18	195	4	22	91	134	262	282
100	1 2	56 70	106	158	G1	32	22	200	20	238	5	25	108	162	314	332
125	1 2	70 90	132	192	G1	32	22	235	23	272	5	28	121	174	341	357
160	1 2	90 110	160	232	G ¹ / ₄	36	22	280	25	316	5	30	143	191	386	406
200	1 2	110 140	200	285	G ¹ / ₄	40	26	340	30	385	5	35	190	224	466	490
250	1 2	140 180	250	365	G ¹ / ₂	56	33	420	32	500	8	40	205	290	570	606
320	1 2	180 220	320	450	G ¹ / ₂	63	39	520	37	600	8	45	250	358	684	723

All dimensions are in millimetres unless otherwise stated.

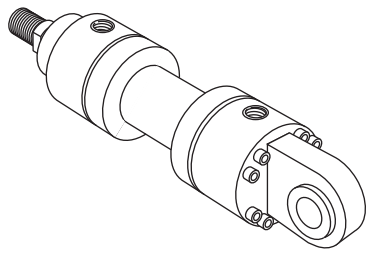

Style MP3
 Cap Fixed Eye

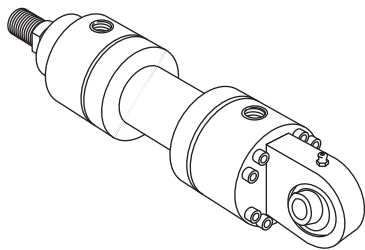
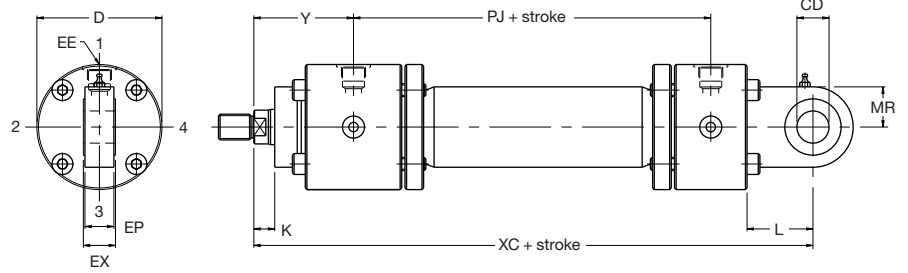

Style MP5
 Cap Fixed Eye
 with Spherical Bearing

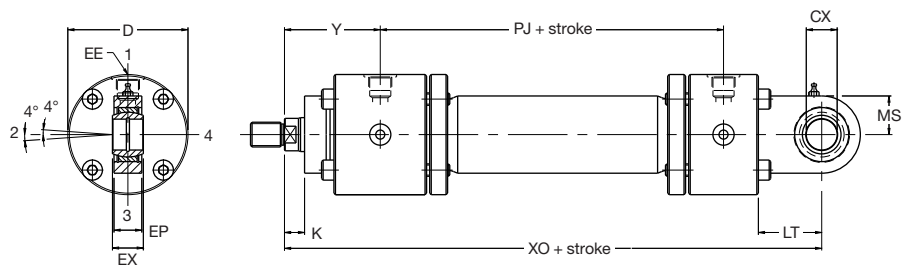

Dimensions – MP3 and MP5 See also Rod End Dimensions, page 9

Bore Ø	Rod No.	Rod Ø	CD ^{H9} & CX ^{H7}	D _{max}	EE (BSPP)	EP	EX _{h12}	K	L & LT	MR & MS	Y	+ Stroke	
												PJ	XC & XO
40	1 2	22 28	20	78	G ¹ / ₂	18	20	13	41	25	71	97	231
50	1 2	28 36	25	95	G ¹ / ₂	22	25	14	52	32	72	111	257
63	1 2	36 45	32	116	G ³ / ₄	27	32	16	65	40	82	117	289
80	1 2	45 56	40	130	G ³ / ₄	35	40	18	82	50	91	134	332
100	1 2	56 70	50	158	G ¹	40	50	20	95	63	108	162	395
125	1 2	70 90	63	192	G ¹	52	63	23	103	71	121	174	428
160	1 2	90 110	80	232	G ¹ / ₄	66	80	25	135	90	143	191	505
200	1 2	110 140	100	285	G ¹ / ₄	84	100	30	165	112	190	224	615
250	1 2	140 180	125	365	G ¹ / ₂	102	125	32	223	160	205	290	773
320	1 2	180 220	160	450	G ¹ / ₂	130	160	37	270	200	250	358	930

All dimensions are in millimetres unless otherwise stated.

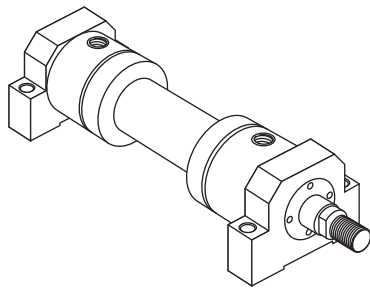

Style MS2
 Foot Mounting

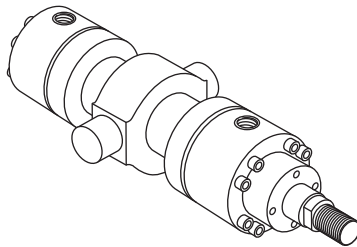
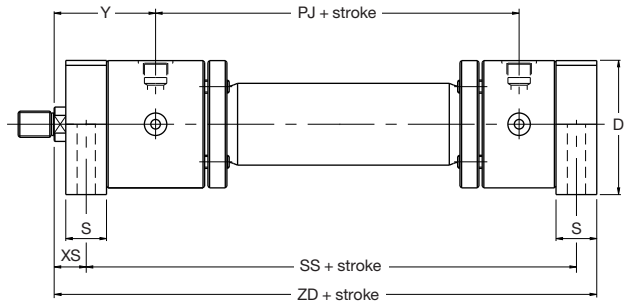
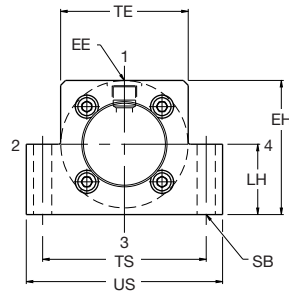

Style MT4
 Intermediate Fixed Trunnion

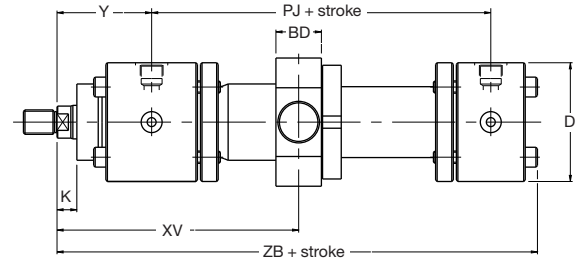
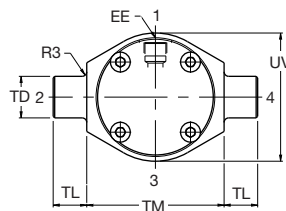

Note: XV dimension to be specified by customer. Where the minimum dimension is unacceptable, please consult the factory.

Dimensions – MS2 and MT4 See also Rod End Dimensions, page 9 and Trunnion Blocks, page 13

Bore Ø	Rod No.	Rod Ø	BD max	D & TE max	EE (BSPP)	EH	K	LH h10	S	SB H13	TD f8	TL js15	TM h12	TS js13	US	UV max	XS	XV min	Y	Min. Stroke MT4	+ Stroke				
																					PJ	SS	XV max	ZB max	ZD
40	1 2	22 28	30	78	G $\frac{1}{2}$	82	13	43	25	11	20	16	90	100	120	78	19.5	130	71	37	97	183	93	198	215
50	1 2	28 36	35	95	G $\frac{1}{2}$	100	14	52	32	14	25	20	105	120	145	95	22	142	72	40	111	199	102	213	237
63	1 2	36 45	45	116	G $\frac{3}{4}$	120	16	62	32	18	32	25	120	150	180	116	29	160	82	53	117	211	107	236	256
80	1 2	45 56	50	130	G $\frac{3}{4}$	135	18	70	40	22	40	32	135	170	210	130	34	180	91	53	134	236	122	262	290
100	1 2	56 70	60	158	G1	161	20	82	50	26	50	40	160	205	250	158	32	210	108	58	162	293	152	314	350
125	1 2	70 90	75	192	G1	196	23	100	56	33	63	50	195	245	300	195	32	235	121	78	174	321	157	341	381
160	1 2	90 110	90	232	G $\frac{1}{4}$	238	25	119	60	33	80	63	240	295	350	240	36	273	143	96	191	364	177	386	430
200	1 2	110 140	110	285	G $\frac{1}{4}$	288	30	145	72	39	100	80	295	350	415	390	39	337	190	70	224	447	267	466	522
250	1 2	140 180	135	365	G $\frac{1}{2}$	-	32	-	-	-	125	100	370	-	-	480	-	393	205	95	290	-	298	570	-
320	1 2	180 220	175	450	G $\frac{1}{2}$	-	37	-	-	-	160	125	470	-	-	600	-	486	250	116	358	-	370	684	-

All dimensions are in millimetres unless otherwise stated.

Piston Rod End Styles

MMB cylinders are supplied with standard metric male and female rod ends to ISO 4395. They can also be supplied with other rod end threads, eg: ISO metric coarse, Unified, British Standard etc., or to the customer's special requirements.

Rod End Codes 4 and 9

Each cylinder bore size is offered with two diameters of piston rod – the smaller is designated no. 1 and the larger, no. 2. The standard male rod end threads, to ISO 6020/1, are designated code 4 and female threads are designated code 9.

Rod End Code 3

Non-standard rod ends are designated code 3. Orders for these should include dimensioned sketches and descriptions, showing dimensions KK or KF, A, rod stand out (WF – VE) and the thread form required.

Rod End Code 7

Where the same pin diameter is required at the head and cap ends of a cylinder with mounting styles MP3 or MP5 and a no. 2 piston rod, a code 7 rod end should be specified.

Wrench Flats

Piston rods up to and including 140mm in diameter are supplied with the wrench flats D shown in the table below. Rods above 140mm in diameter feature four drilled holes to accept a pin wrench.

Rod End Codes 4 & 7

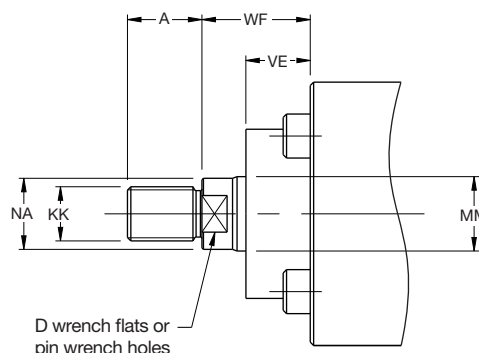

Rod End Code 9

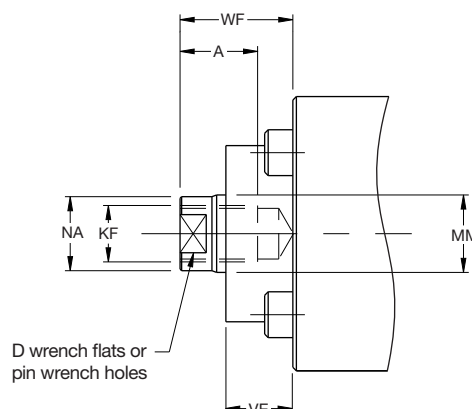

Rod End Dimensions

Bore Ø	Rod No.	MM Rod Ø	Code 4		Code 7		Code 9		D	NA	VE	WF
			KK	A	KK	A	KF	A				
40	1	22	M16x1.5	22	–	–	M16x1.5	22	18	21	19	32
	2	28	M20x1.5	28	M16x1.5	22	M20x1.5	28	22	26		
50	1	28	M20x1.5	28	–	–	M20x1.5	28	22	26	24	38
	2	36	M27x2	36	M20x1.5	28	M27x2	36	30	34		
63	1	36	M27x2	36	–	–	M27x2	36	30	34	29	45
	2	45	M33x2	45	M27x2	36	M33x2	45	39	43		
80	1	45	M33x2	45	–	–	M33x2	45	39	43	36	54
	2	56	M42x2	56	M33x2	45	M42x2	56	48	54		
100	1	56	M42x2	56	–	–	M42x2	56	48	54	37	57
	2	70	M48x2	63	M42x2	56	M48x2	63	62	68		
125	1	70	M48x2	63	–	–	M48x2	63	62	68	37	60
	2	90	M64x3	85	M48x2	63	M64x3	85	80	88		
160	1	90	M64x3	85	–	–	M64x3	85	80	88	41	66
	2	110	M80x3	95	M64x3	85	M80x3	95	100	108		
200	1	110	M80x3	95	–	–	M80x3	95	100	108	45	75
	2	140	M100x3	112	M80x3	95	M100x3	112	128	138		
250	1	140	M100x3	112	–	–	M100x3	112	128	138	64	96
	2	180	M125x4	125	M100x3	112	M125x4	125	Ø15 x 4	175		
320	1	180	M125x4	125	–	–	M125x4	125	Ø15 x 4	175	71	108
	2	220	M160x4	160	M125x4	125	M160x4	160	Ø15 x 4	214		

All dimensions are in millimetres unless otherwise stated.

Accessory Selection

The accessories and corresponding mounting brackets supplied for use at the piston rod end of a cylinder are selected by reference to the rod end thread, shown on page 9, while the same mounting brackets, when used at the cap end of pivot mounted cylinders, are selected by pin size – see dimensions CD and CX on page 7.

Pin Diameters

To obtain the same pin diameter at the head and cap ends of pivot-mounted cylinders (Styles MP3 and MP5), a code 4 rod end should be specified with a no. 1 rod, and a code 7 rod end should be specified with a no. 2 rod. This ensures that the correct rod end thread is supplied to accept the appropriate spherical bearing or plain bearing rod eye or rod clevis – see Rod End Dimensions, page 9.

Rod End

- Rod clevis and pivot pin – page 10
- Rod eye with plain bearing – page 11
- Clevis bracket and pivot pin – page 11
- Rod eye with spherical bearing – page 12
- Mounting bracket and pivot pin – page 12

Cap End

- Clevis bracket and pivot pin – for style MP3 and MP5 mountings – page 11
- Mounting bracket and pivot pin – for style MP3 and MP5 mountings – page 12

Cylinder Body

- Trunnion blocks for style MT4 – page 13

Rod Clevis and Pivot Pin AP2 ISO 8132

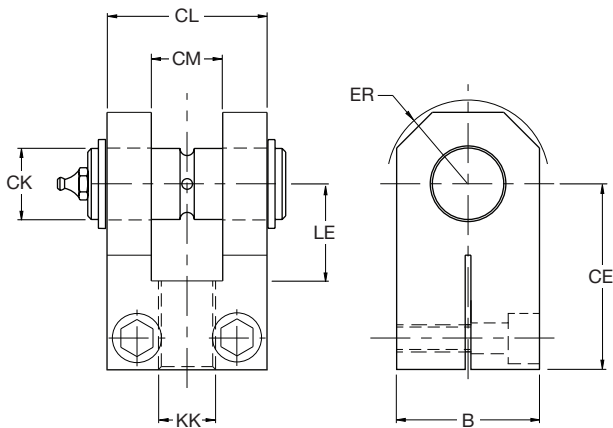

For larger sizes, please consult factory.

Part No.	B	CE js13	CK H9/f8	CL h16	CM A13	ER max	KK	LE min	Mass kg	Nominal Force kN
0962130020	40	52	20	45	20	25	M16x1.5	27	0.6	20
0962130025	50	65	25	56	25	32	M20x1.5	34	1.1	32
0962130032	65	80	32	70	32	40	M27x2	41	2.2	50
0962130040	80	97	40	90	40	50	M33x2	51	4.4	80
0962130050	100	120	50	110	50	63	M42x2	63	7.6	125
0962130063	120	140	63	140	63	71	M48x2	75	17.7	200
0962130080	140	180	80	170	80	90	M64x3	94	30.6	320

All dimensions are in millimetres unless otherwise stated.

Rod Eye with Plain Bearing AP4 ISO 8132

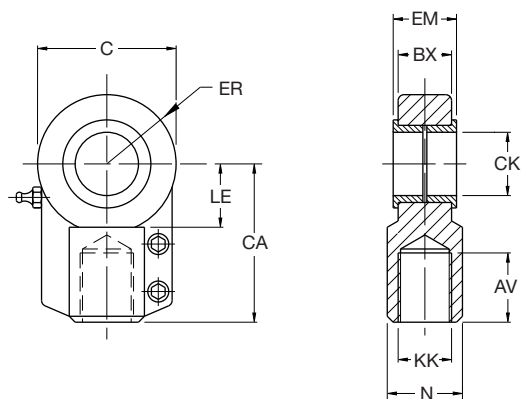

Part No.	AV min	BX max	C max	CA JS13	CK H9	EM h12	ER max	KK	LE min	N max	Mass kg	Nominal Force kN
148729	23	17.5	47	52	20	20	25	M16x1.5	20.5	28	0.4	20
148730	29	22	58	65	25	25	32	M20x1.5	25.5	31	0.7	32
148731	37	28	70	80	32	32	40	M27x2	30	38	1.2	50
148732	46	34	89	97	40	40	50	M33x2	39	47	2.1	80
148733	57	42	108	120	50	50	63	M42x2	47	58	4.4	125
148734	64	53.5	132	140	63	63	72.5	M48x2	58	70	7.6	200
148735	86	68	168	180	80	80	92	M64x3	74	91	14.5	320
148737	96	85.5	210	210	100	100	114	M80x3	94	110	28	500
148739	113	105	262	260	125	125	160	M100x3	116	135	43	800
148740	126	133	326	310	160	160	200	M125x4	145	165	80	1250

Clevis Bracket and Pivot Pin AB4 ISO 8132 Form A

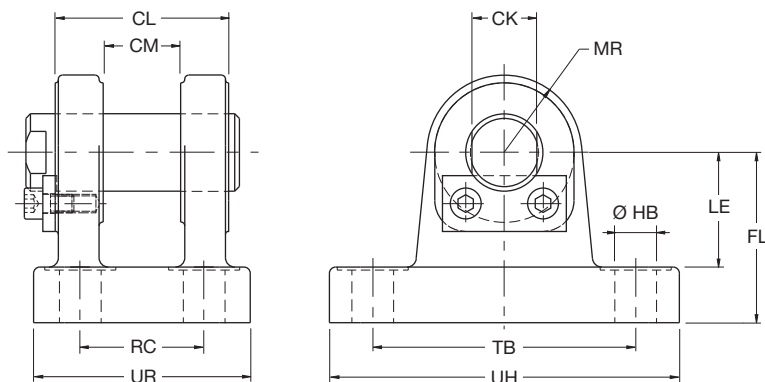

For larger sizes, please consult factory.

Part No.	CK H9/m6	CL h16	CM A13	FL js12	HB H13	LE min	MR max	RC js14	TB js14	UH max	UR max	Mass kg	Nominal Force kN
0962110020	20	45	20	45	11	30	20	32	75	98	58	1.1	20
0962110025	25	56	25	55	13.5	37	25	40	85	113	70	2.0	32
0962110032	32	70	32	65	17.5	43	32	50	110	143	85	3.5	50
0962110040	40	90	40	76	22	52	40	65	130	170	108	6	80
0962110050	50	110	50	95	26	65	50	80	170	220	130	12	125
0962110063	63	140	63	112	33	75	63	100	210	270	160	19	200
0962110080	80	170	80	140	39	95	80	125	250	320	210	38	320

All dimensions are in millimetres unless otherwise stated.

Rod Eye with Spherical Bearing AP6 ISO 8132

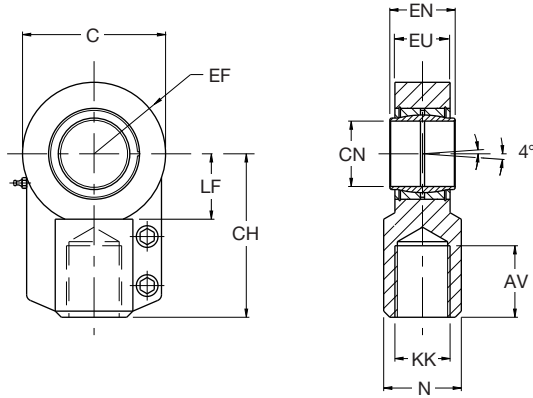

Part No.	AV min	C max	CH js13	CN H7	EF max	EN h12	EU max	KK	LF min	N max	Mass kg	Nominal Force kN
145239	23	47	52	20	25	20	17.5	M16x1.5	20.5	28	0.4	20
145240	29	58	65	25	32	25	22	M20x1.5	25.5	31	0.7	32
145241	37	72	80	32	40	32	28	M27x2	30	38	1.2	50
145242	46	90	97	40	50	40	34	M33x2	39	47	2.1	80
145243	57	110	120	50	63	50	42	M42x2	47	58	4.4	125
145244	64	136	140	63	72.5	63	53.5	M48x2	58	70	7.6	200
145245	86	170	180	80	92	80	68	M64x3	74	91	14.5	320
148724	96	212	210	100	114	100	85.5	M80x3	94	110	28	500
148726	113	265	260	125	160	125	105	M100x3	116	135	43	800
148727	126	326	310	160	200	160	133	M125x4	145	165	80	1250

Mounting Bracket and Pivot Pin AB3 ISO 8132 Form B

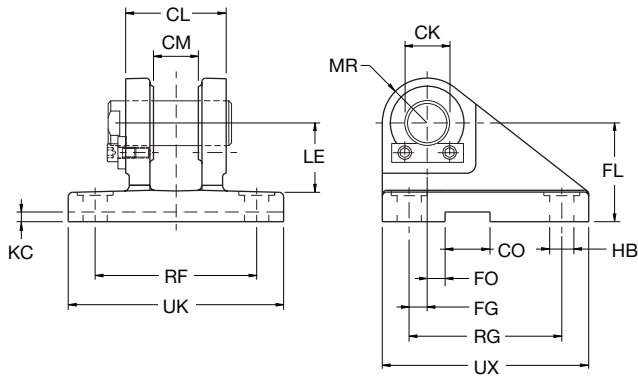

For larger sizes, please consult factory.

Part No.	CK H9/m6	CL h16	CM A13	CO N9	FG JS14	FL js13	FO JS14	HB H13	KC +0.3	LE min	MR max	RF js13	RG js13	UK max	UX max	Mass kg	Nominal Force kN
0962120020	20	45	20	16	7.5	45	10	11	4.3	30	20	75	70	100	95	1.5	20
0962120025	25	56	25	25	10	55	10	13.5	5.4	37	25	90	85	120	115	3	32
0962120032	32	70	32	25	14.5	65	6	17.5	5.4	43	32	110	110	145	145	5	50
0962120040	40	90	40	36	17.5	76	6	22	8.4	52	40	140	125	185	170	9.6	80
0962120050	50	110	50	36	25	95	-	26	8.4	65	50	165	150	215	200	15.5	125
0962120063	63	140	63	50	33	112	-	33	11.4	75	63	210	170	270	230	27.5	200
0962120080	80	170	80	50	45	140	-	39	11.4	95	80	250	210	320	280	47	320

All dimensions are in millimetres unless otherwise stated.

Trunnion Block AT4 ISO 8132

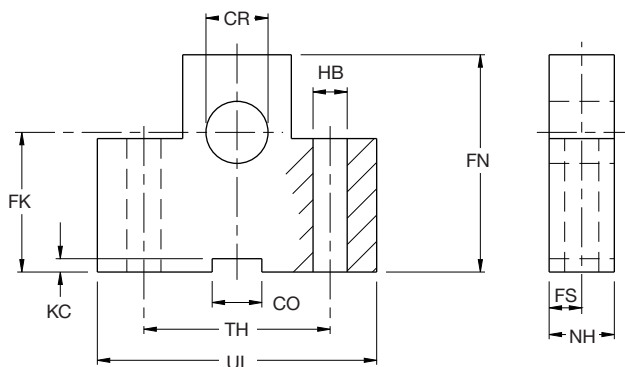

For larger sizes, please consult factory.

Bore Ø	Part No.	CO N9	CR H7	FK JS12	FN max	FS js13	HB H13	KC +0.3	NH max	TH js13	UL max	Nominal Force kN
40	149333	16	20	45	70	10	11	4.3	21	60	90	20
50	149334	25	25	55	80	12	13.5	5.4	26	80	110	32
63	149335	25	32	65	100	15	17.5	5.4	33	110	150	50
80	149336	36	40	76	120	16	22	8.4	41	125	170	80
100	149337	36	50	95	140	20	26	8.4	51	160	210	125
125	149338	50	63	112	180	25	33	11.4	61	200	265	200
160	149339	50	80	140	220	31	39	11.4	81	250	325	320

Cylinder Mounting Information

Mounting Bolts

Mounting bolts with a strength to ISO 898/1 grade 12.9 should be used for attaching cylinders. Bolts should be torque loaded to their manufacturer's recommended figures.

Head and Cap Retention Bolts

If damage or corrosion is found on removal, replacement bolts with a minimum strength to ISO 898/1 grade 12.9 must be fitted. Head and cap bolts should be torque tightened progressively in a diagonal sequence to the figures shown in the table.

Bore Ø	Flange Bolts	
	Torque Load (Nm)	Bolt Size
40 50	36	M8
63 80	123	M12
100	196	M14
125 160 200	305	M16
250	595	M20
320	1030	M24

Cylinder Masses

The following table shows the masses of MMB cylinders for each mounting style at zero stroke; a stroke adder for each 10mm of stroke can then be calculated. Where applicable, accessory masses can be added to give a gross mass for the complete assembly – see pages 10-12.

Bore Ø	Rod No.	Mounting Styles at Zero Stroke, in kg					+ per 10mm Stroke kg
		MF1, MF2	MF3, MF4	MP3, MP5	MS2	MT4	
40	1	6.72	7.13	6.27	8.27	6.64	0.08
	2	6.75	7.16	6.30	8.30	6.67	0.10
50	1	10.77	11.38	10.00	13.75	10.41	0.15
	2	10.81	11.42	10.04	13.79	10.45	0.18
63	1	17.95	18.75	16.71	22.06	17.60	0.23
	2	18.02	18.82	16.78	22.13	17.67	0.27
80	1	25.4	26.9	24.2	31.7	24.0	0.34
	2	25.5	27.0	24.3	31.8	24.1	0.41
100	1	44.3	46.5	43.3	56.4	43.1	0.53
	2	44.5	46.7	43.5	56.6	43.3	0.64
125	1	69.0	71.2	69.3	90.4	70.3	0.76
	2	69.4	71.6	69.7	90.8	70.7	0.96
160	1	-	117.2	119.9	147.3	118.2	1.22
	2	-	117.8	120.5	147.9	118.8	1.46
200	1	-	214.6	225.2	266.3	219.7	1.81
	2	-	216.0	226.6	267.7	221.1	2.26
250	1	-	438.3	462.6	-	432.7	2.81
	2	-	440.8	465.1	-	435.2	3.59
320	1	-	802.8	866.8	-	824.7	3.98
	2	-	829.7	893.7	-	851.6	4.96

All dimensions are in millimetres unless otherwise stated.

Selecting the Cylinder Diameter

Compression or 'Push' Applications

If the piston rod is in compression, use the 'Push Force' table.

1. Identify the operating pressure closest to that required.
2. In the same column, identify the force required to move the load (always rounding up).
3. In the same row, look along to the cylinder bore required.

If the cylinder envelope dimensions are too large, increase the operating pressure, if possible, and repeat the exercise.

Push Force

Bore Ø	Bore Area mm ²	Cylinder Push Force in kN					
		10 Bar	40 Bar	63 Bar	100 Bar	125 Bar	160 Bar
40	1257	1.3	5.0	7.9	12.6	15.7	20.1
50	1964	2.0	7.9	12.4	19.6	24.6	31.4
63	3118	3.1	12.5	19.6	31.2	39.0	49.9
80	5027	5.0	20.1	31.7	50.3	62.8	80.4
100	7855	7.9	31.4	49.5	78.6	98.2	126
125	12272	12.3	49.1	77.3	123	153	196
160	20106	20.1	80.4	127	201	251	322
200	31416	31.4	126	198	314	393	503
250	49087	49.1	196	309	491	614	785
320	80425	80.4	322	507	804	1005	1287

Tension or 'Pull' Applications

If the piston rod is in tension, use the 'Deduction for Pull Force' table. To determine the pull force:

1. Follow the procedure given for 'push' applications, as described above.
2. Using the 'Deduction for Pull Force' table below, establish the appropriate reduction in force.
3. Deduct this from the original 'Push' force. The resultant is the net force available to move the load.

If this force is not large enough, repeat the process with a higher system operating pressure or larger cylinder diameter.

Deduction for Pull Force

Rod Ø	Rod Area mm ²	Reduction in Force in kN					
		10 Bar	40 Bar	63 Bar	100 Bar	125 Bar	160 Bar
22	380	0.4	1.5	2.4	3.8	4.8	6.1
28	616	0.6	2.5	3.9	6.2	7.7	9.9
36	1018	1.0	4.1	6.4	10.2	12.7	16.3
45	1590	1.6	6.4	10.0	15.9	19.9	25.5
56	2463	2.5	9.9	15.6	24.6	30.8	39.4
70	3848	3.8	15.4	24.2	38.5	48.1	61.6
90	6362	6.4	25.5	40.1	63.6	79.6	102
110	9503	9.5	38.0	59.9	95.1	119	152
140	15394	15.4	61.6	97.0	154	193	246
180	25447	25.4	102	160	254	318	407
220	38013	38.0	152	240	380	475	608

inPHorm

For assistance with the calculation of cylinder bore size, refer to the inPHorm selection program HY07-1260/Eur.

All dimensions are in millimetres unless otherwise stated.

Selecting the Piston Rod

To select a piston rod for thrust (push) conditions:

1. Determine the mounting style, type of rod end connection and load guidance to be used. Consult the Stroke Factor table below and identify the appropriate factor for the application.
2. Using this stroke factor, determine the 'basic length' from the equation:

$$\text{Basic Length} = \text{Net Stroke} \times \text{Stroke Factor}$$

(The Piston Rod Selection Chart, on page 16, is prepared for the standard rod extension beyond the face of the gland retainer. For rod extensions greater than standard, add the increase to the stroke to arrive at the 'basic length'.)

3. Find the load imposed for the thrust application by multiplying the full bore area of the cylinder by the system pressure, or by referring to the Push and Pull Force tables on page 14.
4. Using the Piston Rod Selection Chart on page 16, look along the values of 'basic length' and 'thrust' as found in 2. and 3. above, and note the point of intersection.

The correct piston rod diameter is read from the curved line **above** the point of intersection.

For tensile (pull) loads, the rod size is selected by specifying standard cylinders with standard rod diameters and using them at or below the rated pressure.

Stroke Factors

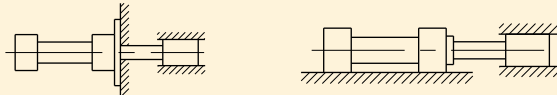
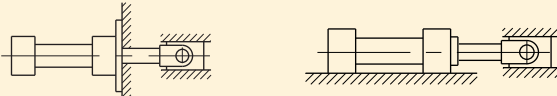
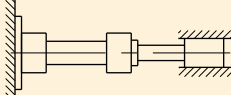
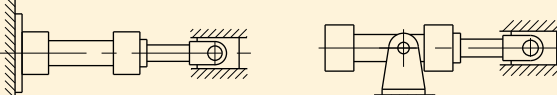
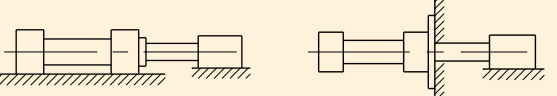
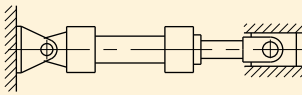
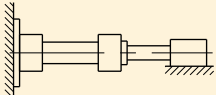
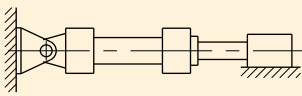
Cylinder Mounting Style	Rod End Connection and Load Guidance	Type of Mounting	Apply Stroke Factor of
MF1 MF3 MS2	Front flange and foot mountings		0.5
MF1 MF3 MS2	Front flange and foot mountings		0.7
MF2 MF4	Rear flange mountings		1.0
MF2 MF4 MT4	Rear flange and trunnion mountings		1.5
MF1 MF3 MS2	Front flange and foot mountings		2.0
MP3 MP5	Rear pivot mountings		2.0
MF2 MF4	Rear flange mountings		4.0
MP3 MP5	Rear pivot mountings		4.0

inPHorm

For more accurate sizing, please refer to the European cylinder inPHorm selection program HY07-1260/Eur.

Piston Rod Selection Chart

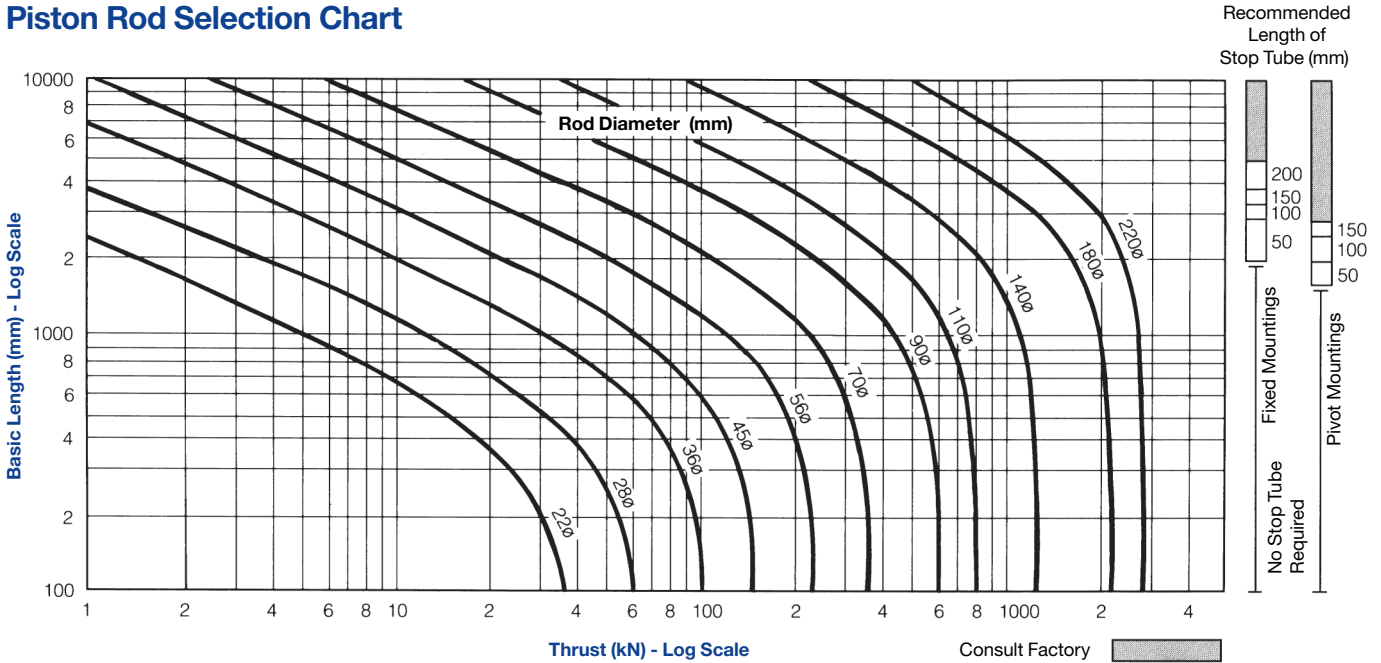

Long Strokes and Stop Tubes

For long stroke cylinders under compressive loads, a stop tube should be used to reduce bearing stress. The required length of stop tube, where necessary, is read from the vertical columns on the right of the chart, by following the horizontal band within which the point of intersection lies. Note that stop tube requirements differ for fixed and pivot mounted cylinders.

When specifying a cylinder with a stop tube, please insert an S (Special) and the net stroke of the cylinder in the order code and state the length of the stop tube. Note that net stroke is equal to the gross stroke of the cylinder less the length of the stop tube. The gross stroke determines the envelope dimensions of the cylinder.

If the required length of stop tube is in the shaded region marked 'consult factory', please submit the following information.

1. Cylinder mounting style.
2. Rod end connection and method of guiding the load.
3. Bore and stroke required, and length of rod extension (Dimension 'K') if greater than standard.
4. Mounting position of cylinder. If at an angle or vertical, specify the direction of the piston rod.
5. Operating pressure of the cylinder if limited to less than the standard pressure for the cylinder selected.

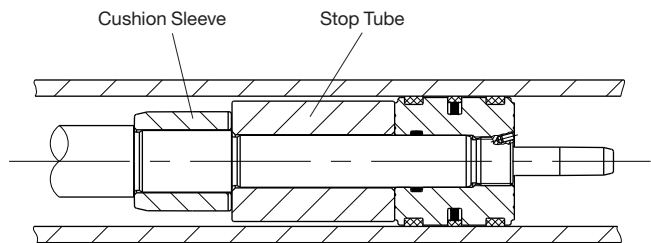

Port Size and Piston Speed

The tables below show piston speeds for standard and oversize ports and connecting lines where the velocity of fluid is 5m/s. If the desired piston speed results in a fluid flow in excess of 5m/s in connecting lines, larger lines with two ports per cap should be considered. Parker recommends that a flow rate of 12m/s in connecting lines should not be exceeded.

Note: Consult the factory if piston speed is to exceed 0.5m/s.

Bore Ø	Standard Cylinder Port			
	Port size (BSPP)	Bore of Connecting Lines	Cap End Flow in l/min at 5m/s	Piston Speed m/s
40	G ¹ / ₂	13	40	0.53
50	G ¹ / ₂	13	40	0.34
63	G ³ / ₄	15	53	0.28
80	G ³ / ₄	15	53	0.18
100	G1	19	85	0.18
125	G1	19	85	0.12
160	G ¹ / ₄	24	136	0.11
200	G ¹ / ₄	24	136	0.07
250	G ¹ / ₂	30	212	0.07
320	G ¹ / ₂	30	212	0.04

Bore Ø	Oversize Cylinder Port			
	Port size (BSPP)	Bore of Connecting Lines	Cap End Flow in l/min at 5m/s	Piston Speed m/s
40	G ³ / ₄	15	53	0.70
50	G ³ / ₄	15	53	0.45
63	G1	19	85	0.45
80	G1	19	85	0.28
100	G ¹ / ₄	24	136	0.29
125	G ¹ / ₄	24	136	0.18
160	G ¹ / ₂	30	212	0.17
200	G ¹ / ₂	30	212	0.11
250	G2	38	340	0.11
320	G2	38	340	0.07

Flange Ports

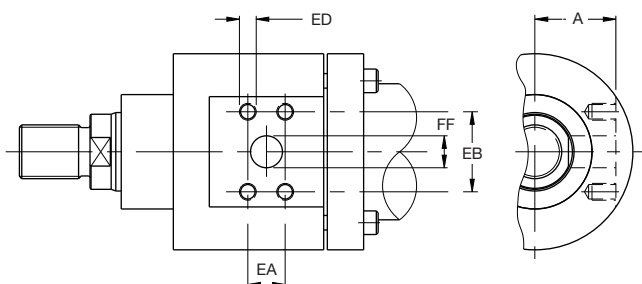

All dimensions are in millimetres unless otherwise stated.

Port Types

Series MMB cylinders are supplied with BSP parallel threaded ports to ISO 1179-1 as standard, or with metric threaded ports to ISO 9974-1 or ISO 6149, spotfaced for sealing washers. Flange ports to ISO 6162 can also be supplied. For higher speed applications, oversize ports or additional ports are available – see tables below.

Bore Ø	Standard Ports			Oversize Ports		
	BSPP	Metric	DN Flange	BSPP	Metric	DN Flange
40	G ¹ / ₂	M22x1.5	–	G ³ / ₄	M27x2	–
50	G ¹ / ₂	M22x1.5	–	G ³ / ₄	M27x2	–
63	G ³ / ₄	M27x2	13	G1	M33x2	–
80	G ³ / ₄	M27x2	13	G1	M33x2	–
100	G1	M33x2	19	G ¹ / ₄	M42x2	25
125	G1	M33x2	19	G ¹ / ₄	M42x2	25
160	G ¹ / ₄	M42x2	25	G ¹ / ₂	M48x2	32
200	G ¹ / ₄	M42x2	25	G ¹ / ₂	M48x2	32
250	G ¹ / ₂	M48x2	32	G2	M60x2	38
320	G ¹ / ₂	M48x2	32	G2	M60x2	38

Flange Port Sizes

Bore Ø	Standard Flange Port					
	DN Flange	A	EA	EB	ED	FF Ø
63	13	51	17.5	38.1	M8x1.25	13
80		58				
100	19	71	22.2	47.6	M10x1.5	19
125		89				
160	25	110	26.2	52.4	M10x1.5	25
200		137				
250	32	177	30.2	58.7	M10x1.5	32
320		220				

Bore Ø	Oversize Flange Port					
	DN Flange	A	EA	EB	ED	FF Ø
100	25	69	26.2	52.4	M10x1.5	25
125		87				
160	32	107	30.2	58.7	M10x1.5	32
200		135				
250	38 ¹	173	36.5	79.3	M16x2	38
320		217				

¹ 400 bar series

An Introduction to Cushioning

Cushioning is recommended as a means of controlling the deceleration of masses, or for applications where piston speeds are in excess of 0.1m/s and the piston will make a full stroke. Cushioning extends cylinder life and reduces undesirable noise and hydraulic shock.

Built-in deceleration devices or 'cushions' are optional and can be supplied at the head and/or cap ends of the cylinder without affecting its envelope or mounting dimensions. Cushions are adjustable via recessed needle valves.

Standard Cushioning

Ideal cushion performance shows an almost uniform absorption of energy along the cushion's length. Where specified, MMB cylinders use cushions which are profiled to give a performance that comes close to the ideal in the majority of applications. The head and cap cushion performance for each bore size is illustrated in the charts on page 19.

Alternative Forms of Cushioning

Special designs can be produced to suit applications where the energy to be absorbed exceeds the performance of the standard cushion. Please consult the factory for details.

Cushion Length

All MMB cylinder cushions incorporate the longest cushion sleeve and spear that can be provided within the standard envelope without decreasing the rod bearing and piston bearing lengths – see table of cushion lengths on page 19.

Cushion Calculations

The charts on page 19 show the energy absorption capacity for each bore and rod combination at the head (annulus) and the cap (full bore) ends of the cylinder. The charts are valid for piston velocities in the range 0.1 to 0.3m/s. For velocities between 0.3 and 0.5m/s, the energy values from the charts should be reduced by 25%. For velocities of less than 0.1m/s where large masses are involved, and for velocities greater than 0.5m/s, a special cushion profile may be required. Please consult the factory.

The cushion capacity of the head end is less than that of the cap, owing to the pressure intensification effect across the piston.

The energy absorption capacity of the cushion decreases with drive pressure, which in normal circuits is the relief valve setting.

inPHorm

Cushioning requirements can be calculated automatically for individual cylinder/load combinations using the European cylinder inPHorm selection program HY07-1260/Eur.

Formulae

Cushioning calculations are based on the formula $E = \frac{1}{2}mv^2$ for horizontal applications. For inclined or vertically downward or upward applications, this is modified to:

$$E = \frac{1}{2}mv^2 + mgl \times 10^{-3} \times \sin\alpha$$

– for inclined/vertically downward direction of mass

$$E = \frac{1}{2}mv^2 - mgl \times 10^{-3} \times \sin\alpha$$

– for inclined/vertically upward direction of mass

Where:

- E = energy absorbed in Joules
- g = acceleration due to gravity = 9.81m/s²
- v = velocity in metres/second
- l = length of cushion in millimetres (see page 19)
- m = mass of load in kilogrammes (including piston, rod and rod end accessories, see pages 10-12 and 19)
- α = angle to the horizontal in degrees
- ρ = pressure in bar

Example

The example shows how to calculate the energy developed by masses moving in a straight line. For non-linear motion, other calculations are required; please consult the factory.

The example assumes that the bore and rod diameters are appropriate for the application. The effects of friction on the cylinder and load have been ignored.

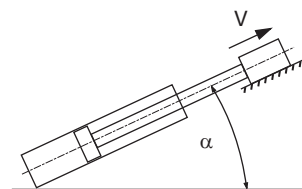

- Bore/rod = 125/90mm (no. 2 rod) with head end cushion
- Pressure = 160 bar
- Mass = 10000kg
- Velocity = 0.5m/s
- Cushion length = 40mm
- α = 15°
- Sin α = 0.26

$$E = \frac{1}{2}mv^2 - mgl \times 10^{-3} \times \sin\alpha$$

$$E = \frac{10000 \times 0.5^2}{2} - 10000 \times 9.81 \times \frac{40}{10^3} \times 0.26$$

$$E = 1250 - 1020 = 230 \text{ Joules}$$

Note that, as velocity is greater than 0.3m/s, the energy absorption figures obtained from the charts on page 19 should be reduced by 25% – see Cushion Calculations, above. Comparison with the cushioning chart curve for this cylinder shows an energy capacity for the head end of 400 Joules. Reducing this by 25% gives a capacity of 300 Joules, so the standard cushion can safely decelerate the 230 Joules in this example.

Where cushion performance figures are critical, our engineers can run a computer simulation to determine accurate cushion performance – please contact the factory for details.

Cushion Energy Absorption Capacity Data

The cushion energy absorption capacity data shown below are based on the maximum fatigue-free pressure developed in the tube. If working life cycle applications of less than 10⁶ cycles

are envisaged, then greater energy absorption figures can be applied. Please consult the factory for further information.

Head End, No. 1 and No. 2 Rods

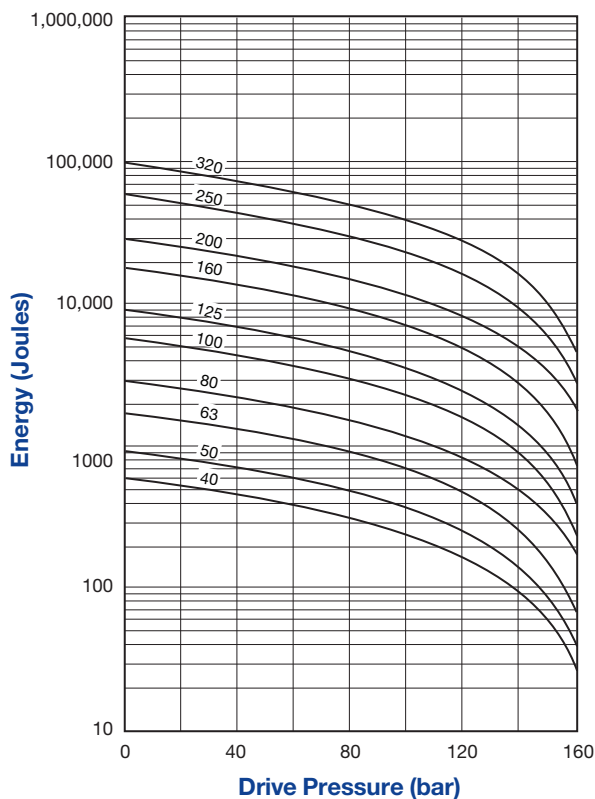

Cap End, No. 1 and No. 2 Rods

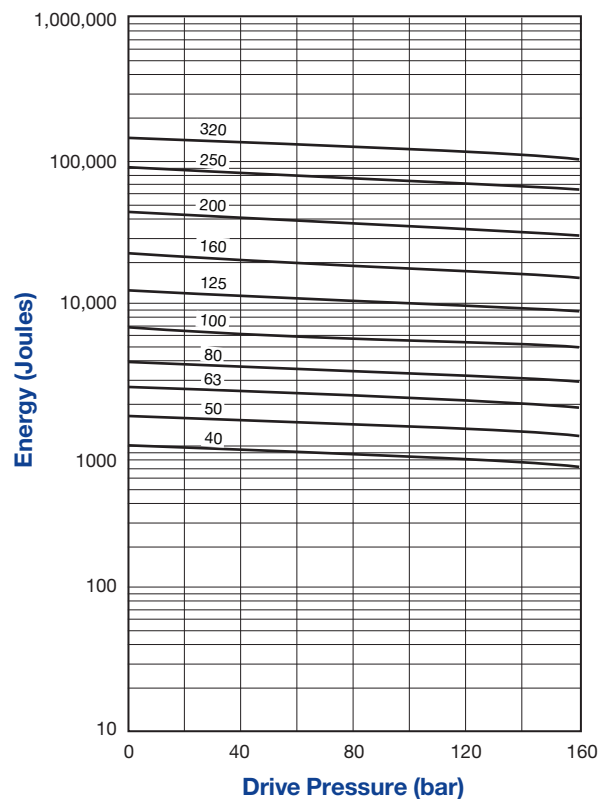

Cushion Length

Bore Ø	Rod No.	Cushion Length	
		Head	Cap
40	1	30	30
	2		
50	1	30	30
	2		
63	1	30	30
	2		
80	1	35	35
	2		
100	1	35	35
	2		
125	1	40	40
	2		
160	1	40	40
	2		
200	1	45	45
	2		
250	1	45	45
	2		
320	1	50	50
	2		

Piston and Rod Mass

Bore Ø	Rod No.	Rod Ø	Piston and Rod at Zero Stroke kg	Rod Only, per 10mm Stroke kg
40	1	22	0.7	0.03
	2			
50	1	28	1.3	0.05
	2			
63	1	36	2.3	0.08
	2			
80	1	45	4.3	0.12
	2			
100	1	56	8.5	0.19
	2			
125	1	70	15	0.30
	2			
160	1	90	29	0.50
	2			
200	1	110	54	0.75
	2			
250	1	140	105	1.2
	2			
320	1	180	208	2.0
	2			
		220	265	3.0

All dimensions are in millimetres unless otherwise stated.

Seals and Fluid Data

See also Gland and Piston Seal Options, page 4

Fluid Group	Seal Materials – a combination of:	Fluid Medium to ISO 6743/4-1982	Temperature Range
1	Nitrile (NBR), PTFE, enhanced polyurethane (AU)	Mineral Oil HH, HL, HLP, HLP-D, HM, HV, MIL-H-5606 oil, air, nitrogen	-20°C to +80°C
2	Nitrile (NBR), PTFE	Water glycol (HFC)	-20°C to +60°C
5	Fluorocarbon elastomer (FPM), PTFE	Fire resistant fluids based on phosphate esters (HFD-R). Also suitable for hydraulic oil at high temperatures or in hot environments. Not suitable for use with Skydrol. See fluid manufacturer's recommendations.	-20°C to +150°C
6	Various compounds including nitrile, enhanced polyurethane, fluorocarbon elastomers and PTFE	Water Oil in water emulsion 95/5 (HFA)	+5°C to +55°C
7		Water in oil emulsion 60/40 (HFB)	+5°C to +60°C

Special Seals

A range of seal options is available for each of the fluid groups listed above – see cylinder model numbers on page 23. Where required, special seals can also be supplied. Please insert an S (Special) in the model number and specify fluid medium when ordering.

Group 6 Seal Life

Seals used with High Water Content Fluids (HFA) are subject to wear due to the poor lubricity of the operating medium. This condition becomes more acute at higher pressures.

Low Friction Applications

For applications where very low friction and an absence of stick-slip are important, low friction seals are available. For details, please consult the factory.

Water Service

Special modifications such as a stainless steel piston rod and plating of internal surfaces are available for high water content fluids. When ordering, please specify the maximum operating pressure or load/speed conditions, as the stainless steel rod is of lower tensile strength than the standard material.

Filtration

Fluid cleanliness should be in accordance with ISO 4406. The quality of filters should be in accordance with the appropriate ISO standards.

The rating of the filter media depends on the system components and the application. The minimum required for hydraulic systems should be class 19/15 to ISO 4406, which equates to 25µ (β10≥75) to ISO 4572.

Warranty

Parker Hannifin warrants cylinders modified for water or high water content fluid service to be free of defects in materials and workmanship, but cannot accept responsibility for premature failure caused by excessive wear resulting from lack of lubricity, or where failure is caused by corrosion, electrolysis or mineral deposits within the cylinder.

Repairs

Although MMB cylinders are designed to make on site maintenance or repairs as easy as possible, some operations should only be carried out in our factory. It is standard policy to fit a cylinder returned to the factory for repair with those replacement parts which are necessary to return it to 'as good as new' condition. Should the condition of the returned cylinder be such that the expense would exceed the cost of a new one, you will be notified.

Service Assemblies and Seal Kits

When ordering Service Assemblies and Seal Kits, please refer to the identification plate on the cylinder body, and supply the following information:

Serial Number - Bore - Stroke - Model Number - Fluid Type

Key to Part Numbers

- 1 Head
- 7 Cap
- 14 Standard gland
- 14a Chevron gland
- 14b Gland bearing
- 15 Cylinder tube
- 17 Standard piston
- 17a Chevron piston – head end
- 17b Chevron piston – cap end
- 18 Cushion sleeve
- 19 Front/rear flange
- 20 Cushion bush retaining ring
- 23 Head/cap securing screw
- 26 O-ring (cylinder body)

- 73 Floating cushion bush
- 125 Standard piston seal
- 126 Energising ring for standard seal 125
- 127 Wear ring for standard piston
- 134¹ Back up washer (gland/head)
- 137 Chevron rod seal assembly
- 139a Wear ring for chevron gland
- 139b Wear rings for chevron gland
- 140a Wear ring for standard gland
- 140b Wear rings for standard gland
- 142 Chevron piston bearing ring
- 143 Chevron piston seal assembly

¹ In some cases, harder O-rings are supplied in place of the O-ring/back-up washer combination.

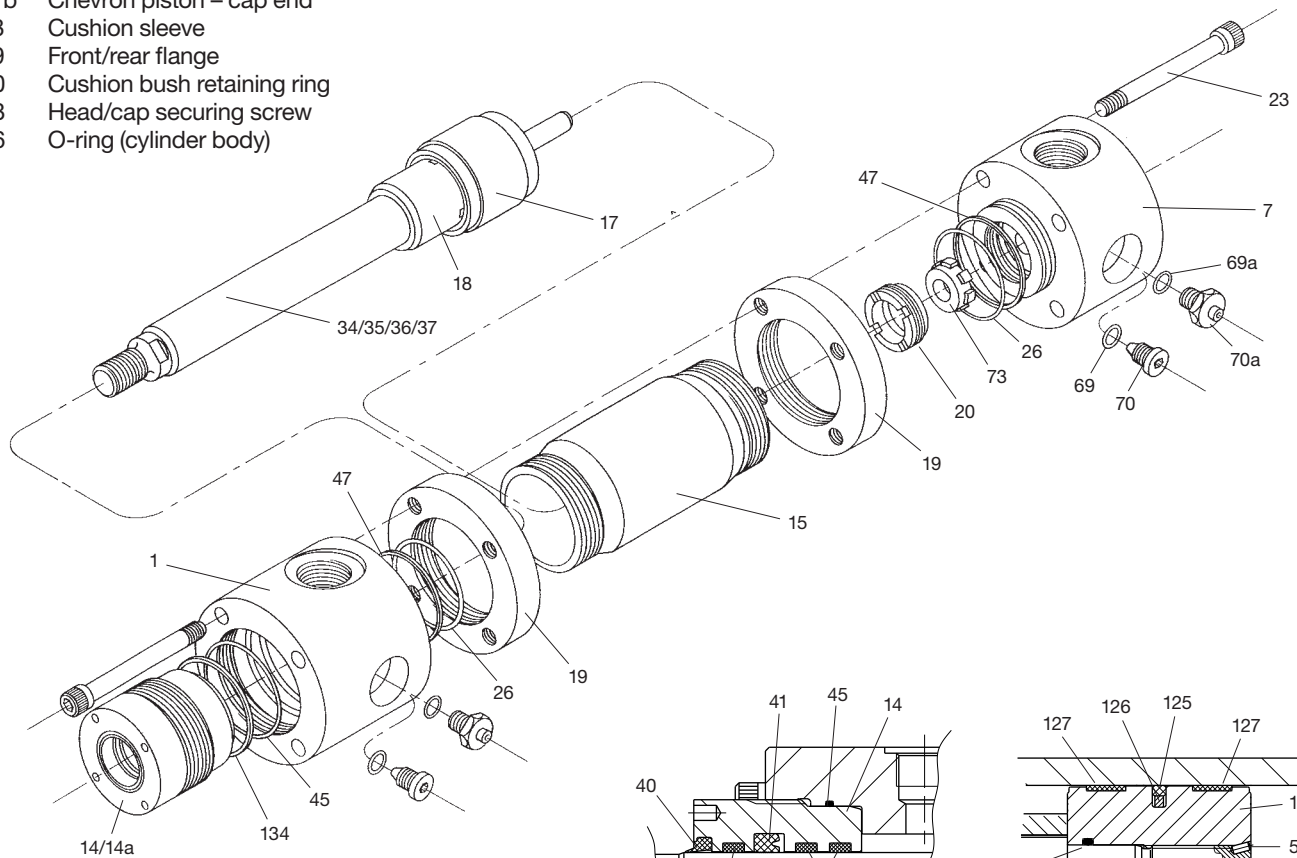

- 34 Piston rod – single rod, no cushion
- 35 Piston rod – single rod, cushion at head end
- 36 Piston rod – single rod, cushion at cap end
- 37 Piston rod – single rod, cushion at both ends
- 40 Gland wiperseal
- 41 Lipseal
- 45 O-ring (gland/head)
- 46 O-ring, piston/rod (2 off – chevron piston)
- 47 Back-up washer (cylinder body)
- 55 Piston locking pin
- 69 O-ring, cushion needle valve
- 69a O-ring, cartridge-type needle valve
- 70 Cushion needle valve
- 70a Cartridge-type needle valve

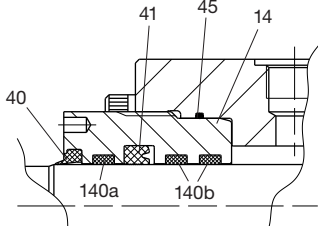

Standard Gland & Seals

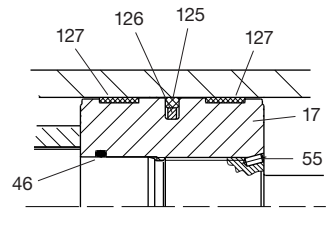

Standard Piston

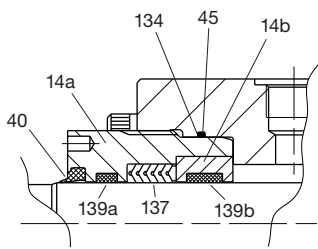

Chevron Gland & Seals

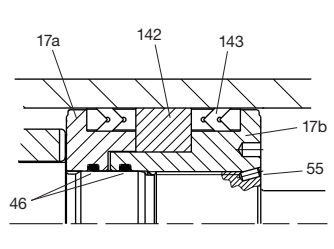

Chevron Piston

Contents and Part Numbers of Seal Kits for Pistons and Glands

See key to part numbers on page 21.

Gland Service Cartridge Kit, Standard and Loadholding Seals

Contains items 14, 40, 41, 45, 134, 140a, 140b.

Gland Service Cartridge Kit, Chevron Seals

Contains items 14a, 14b, 40, 45, 134, 137, 139a, 139b.

Gland Service Kit, Standard and Loadholding Seals

Contains items 40, 41, 45, 134, 140a, 140b.

Gland Service Kit, Chevron Seals

Contains items 40, 45, 134, 137, 139a, 139b.

Piston Service Kit, Standard Seals

Contains 26, 46, 47, 125, 126, 127.

Piston Service Kit, Chevron and Loadholding Seals

Contains 26, 47, 55, 142, 143 and two of 46.

Seal Groups Ordering

All part numbers listed contain standard, Group 1 seals. To order kits with other classes of seals, replace the last digit of the part number shown with the number of the fluid group required. Eg: RG04MMB0221, containing a Group 1 seal, becomes RG04MMB0225 when it contains a Group 5 seal.

Service Kit Order Codes – Piston

Bore Ø	Piston Service Kit Standard Seals	Piston Service Kit Chevron and Loadholding Seals
40	PN040MMB01	PL040MMB01
50	PN050MMB01	PL050MMB01
63	PN063MMB01	PL063MMB01
80	PN080MMB01	PL080MMB01
100	PN100MMB01	PL100MMB01
125	PN125MMB01	PL125MMB01
160	PN160MMB01	PL160MMB01
200	PN200MMB01	PL200MMB01
250	PN250MMB01	PL250MMB01
320	PN320MMB01	PL320MMB01

Service Kit Order Codes – Glands

Bore Ø	Rod Ø	Gland Service Cartridge Kit Standard and Loadholding Seals	Gland Service Cartridge Kit Chevron Seals	Gland Service Kit Standard and Loadholding Seals	Gland Service Kit Chevron Seals
40	22	RG04MMB0221	RGL04MMB0221	RK04MMB0221	RKL04MMB0221
	28	RG04MMB0281	RGL04MMB0281	RK04MMB0281	RKL04MMB0281
50		RG05MMB0281	RGL05MMB0281	RK05MMB0281	RKL05MMB0281
	63	RG05MMB0361	RGL05MMB0361	RK05MMB0361	RKL05MMB0361
80		RG06MMB0361	RGL06MMB0361	RK06MMB0361	RKL06MMB0361
	100	RG06MMB0451	RGL06MMB0451	RK06MMB0451	RKL06MMB0451
125		RG08MMB0451	RGL08MMB0451	RK08MMB0451	RKL08MMB0451
	160	RG08MMB0561	RGL08MMB0561	RK08MMB0561	RKL08MMB0561
200		RG10MMB0561	RGL10MMB0561	RK10MMB0561	RKL10MMB0561
	250	RG10MMB0701	RGL10MMB0701	RK10MMB0701	RKL10MMB0701
320		RG12MMB0701	RGL12MMB0701	RK12MMB0701	RKL12MMB0701
	40	RG12MMB0901	RGL12MMB0901	RK12MMB0901	RKL12MMB0901
50		RG16MMB0901	RGL16MMB0901	RK16MMB0901	RKL16MMB0901
	63	RG16MMB1101	RGL16MMB1101	RK16MMB1101	RKL16MMB1101
80		RG20MMB1101	RGL20MMB1101	RK20MMB1101	RKL20MMB1101
	100	RG20MMB1401	RGL20MMB1401	RK20MMB1401	RKL20MMB1401
125		RG25MMB1401	RGL25MMB1401	RK25MMB1401	RKL25MMB1401
	160	RG25MMB1801	RGL25MMB1801	RK25MMB1801	RKL25MMB1801
200		RG32MMB1801	RGL32MMB1801	RK32MMB1801	RKL32MMB1801
	250	RG32MMB2201	RGL32MMB2201	RK32MMB2201	RKL32MMB2201

All dimensions are in millimetres unless otherwise stated.

80 Bore C Head Cushion page 18 K Double Rod page 4 MF3 Mounting Style MMB Series R Ports N Gland & Piston Types S Special 1 Piston Rod No. 4 Piston Rod End M Rod Thread C Cap Cushion page 18 230 Stroke M Fluid Medium 11 Port Position 44 Air Bleeds

Code	Special Features	Page
S	Optional features	4
S	Oversize ports	17
S	Low friction seals	20
S	Stop tube	16

Or to detailed customer description or drawing

Code	Fluid Medium	Page
M	Group 1	20
C	Group 2	20
D	Group 5	20
A1	Group 6	20
B	Group 7	20

Code	Gland & Piston	Page
N	Standard	4
L	Chevron	4
B	Load holding	4

Code	Port Position	Page
1	Head position 1-4	23
1	Cap position 1-4	23

Code	Port Style	Page
R	BSP parallel to ISO 1179-1	17
M	Metric to ISO 9974-1	17
P	Flange to ISO 6162	17
Y	Metric to ISO 6149	17

Code	Air Bleeds	Page
1	Head position 1-4	23
1	Cap position 1-4	23
00	No air bleeds	23

Code	Piston Rod End	Page
4	Code 4	9
7	Code 7	9
9	Code 9	9
3	Code 3 (drawing req'd.)	9

Code	Piston Rod No.	Page
1	Rod no. 1	9
2	Rod no. 2	9

Code	Mounting Style	Page
MF1	Head rectangular flange	5
MF2	Cap rectangular flange	5
MF3	Head circular flange	6
MF4	Cap circular flange	6
MP3	Cap fixed eye	7
MP5	Cap fixed eye with spherical bearing	7
MS2	Foot mounting	8
MT4	Intermediate fixed trunnion	8

Key

Required for basic cylinder
 Indicate optional features or leave blank

Ports, Air Bleeds and Cushion Adjusters

Standard port location is position 1. Cushion adjustment needle valves, where specified, are at position 2.

Double Rod Cylinders – Example

100 K MF3 MMB R N 1 4 M 1 4 M 180 A1 11 44

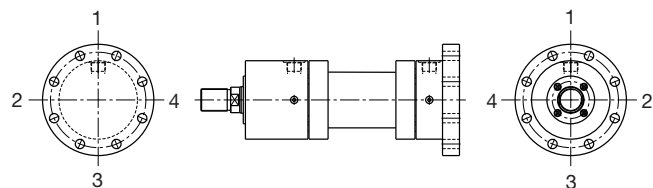

Parker Worldwide

Europe, Middle East, Africa

AE – United Arab Emirates,
Dubai

Tel: +971 4 8127100
parker.me@parker.com

AT – Austria, Wiener Neustadt

Tel: +43 (0)2622 23501-0
parker.austria@parker.com

AT – Eastern Europe, Wiener
Neustadt

Tel: +43 (0)2622 23501 900
parker.easteurope@parker.com

AZ – Azerbaijan, Baku

Tel: +994 50 2233 458
parker.azerbaijan@parker.com

BE/LU – Belgium, Nivelles

Tel: +32 (0)67 280 900
parker.belgium@parker.com

BY – Belarus, Minsk

Tel: +375 17 209 9399
parker.belarus@parker.com

CH – Switzerland, Etoy

Tel: +41 (0)21 821 87 00
parker.switzerland@parker.com

CZ – Czech Republic, Klecany

Tel: +420 284 083 111
parker.czechrepublic@parker.com

DE – Germany, Kaarst

Tel: +49 (0)2131 4016 0
parker.germany@parker.com

DK – Denmark, Ballerup

Tel: +45 43 56 04 00
parker.denmark@parker.com

ES – Spain, Madrid

Tel: +34 902 330 001
parker.spain@parker.com

FI – Finland, Vantaa

Tel: +358 (0)20 753 2500
parker.finland@parker.com

FR – France, Contamine s/Arve

Tel: +33 (0)4 50 25 80 25
parker.france@parker.com

GR – Greece, Athens

Tel: +30 210 933 6450
parker.greece@parker.com

HU – Hungary, Budapest

Tel: +36 1 220 4155
parker.hungary@parker.com

IE – Ireland, Dublin

Tel: +353 (0)1 466 6370
parker.ireland@parker.com

IT – Italy, Corsico (MI)

Tel: +39 02 45 19 21
parker.italy@parker.com

KZ – Kazakhstan, Almaty

Tel: +7 7272 505 800
parker.easteurope@parker.com

NL – The Netherlands, Oldenzaal

Tel: +31 (0)541 585 000
parker.nl@parker.com

NO – Norway, Asker

Tel: +47 66 75 34 00
parker.norway@parker.com

PL – Poland, Warsaw

Tel: +48 (0)22 573 24 00
parker.poland@parker.com

PT – Portugal, Leca da Palmeira

Tel: +351 22 999 7360
parker.portugal@parker.com

RO – Romania, Bucharest

Tel: +40 21 252 1382
parker.romania@parker.com

RU – Russia, Moscow

Tel: +7 495 645-2156
parker.russia@parker.com

SE – Sweden, Spånga

Tel: +46 (0)8 59 79 50 00
parker.sweden@parker.com

SK – Slovakia, Banská Bystrica

Tel: +421 484 162 252
parker.slovakia@parker.com

SL – Slovenia, Novo Mesto

Tel: +386 7 337 6650
parker.slovenia@parker.com

TR – Turkey, Istanbul

Tel: +90 216 4997081
parker.turkey@parker.com

UA – Ukraine, Kiev

Tel +380 44 494 2731
parker.ukraine@parker.com

UK – United Kingdom, Warwick

Tel: +44 (0)1926 317 878
parker.uk@parker.com

ZA – South Africa, Kempton Park

Tel: +27 (0)11 961 0700
parker.southafrica@parker.com

North America

CA – Canada, Milton, Ontario

Tel: +1 905 693 3000

US – USA, Cleveland

(industrial)
Tel: +1 216 896 3000

US – USA, Elk Grove Village

(mobile)
Tel: +1 847 258 6200

Asia Pacific

AU – Australia, Castle Hill

Tel: +61 (0)2-9634 7777

CN – China, Shanghai

Tel: +86 21 2899 5000

HK – Hong Kong

Tel: +852 2428 8008

IN – India, Mumbai

Tel: +91 22 6513 7081-85

JP – Japan, Fujisawa

Tel: +81 (0)4 6635 3050

KR – South Korea, Seoul

Tel: +82 2 559 0400

MY – Malaysia, Shah Alam

Tel: +60 3 7849 0800

NZ – New Zealand, Mt Wellington

Tel: +64 9 574 1744

SG – Singapore

Tel: +65 6887 6300

TH – Thailand, Bangkok

Tel: +662 717 8140

TW – Taiwan, Taipei

Tel: +886 2 2298 8987

South America

AR – Argentina, Buenos Aires

Tel: +54 3327 44 4129

BR – Brazil, Cachoeirinha RS

Tel: +55 51 3470 9144

CL – Chile, Santiago

Tel: +56 2 623 1216

MX – Mexico, Apodaca

Tel: +52 81 8156 6000

EMEA Product Information Centre

Free phone: 00 800 27 27 5374

(from AT, BE, CH, CZ, DE, DK, EE, ES, FI, FR, IE, IL,
IS, IT, LU, MT, NL, NO, PL, PT, RU, SE, SK, UK, ZA)

US Product Information Centre

Toll-free number: 1-800-27 27 537

www.parker.com

